

BI-30U/O



FEATURES

- Monitor and control remotely with Wi-Fi connectivity

- Accepts custom panels for an integrated look within cabinetry or stainless-steel accessory panels and handles to match other Sub-Zero, Wolf, and Cove products*

- Preserves refrigerated foods with cool, moist air and frozen foods with frigid, dry air

- Fight spoilage and odors with a NASA-inspired air purification system

- Locks in cold air to ensure freshness with magnetic door seals

- Keeps produce fresher with high-humidity, sealed crisper and deli drawers

- Controls temperature within one degree of setpoint

- Filters ice, removing contaminants, chlorine taste, and odor

- Yields ice automatically and "max ice" for additional production

- Ensures excellent visibility with bright lights

- Refer to freshness cards for tips on food preservation, use, and care

ACCESSORIES

- Air Purification Cartridge

- Dual Installation Kit

- Egg Container

- Pro Handle

- Pro Handle

- Stainless Steel Dual Flush Inset Door Panel with Pro Handle

- Stainless Steel Dual Flush Inset Door Panel with Tubular Handle

- Stainless Steel Flush Inset Door Panel with Pro Handle

- Stainless Steel Flush Inset Door Panel with Tubular Handle

- Stainless Steel Flush Inset Drawer Panel with Pro Handle

- Stainless Steel Flush Inset Drawer Panel with Tubular Handle

- Stainless Steel Kickplate

- Stainless Steel Side Panel

- Tubular Handle

- Tubular Handle

- White Side Panel

Accessories are available through an authorized dealer. For local dealer information, visit subzero-wolf.com/locator.



HANDLE ACCESSORIES

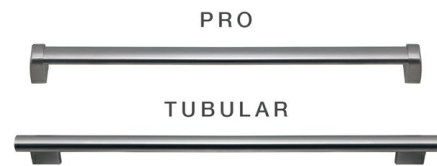

PRODUCT DETAILS

REFRIGERATOR

- LED refrigerator and freezer lights
- 4 glass refrigerator shelves (3 adjustable; 1 stationary)
- 1 high-humidity crisper drawer with adjustable dividers
- 1 deli drawer with adjustable dividers
- 3 door bins (2 adjustable; 1 stationary)
- 1 adjustable dairy compartment

FREEZER

- Full-extension roll-out freezer drawer
- Automatic ice maker with removable ice container

PRODUCT SPECIFICATIONS

Model	BI-30U/O
Dimensions	30"W x 84"H x 24"D
Refrigerator Capacity	12.9 cu. ft.
Freezer Capacity	4.1 cu. ft.
Electrical Supply	115 VAC, 60 Hz
Electrical Service	15 amp dedicated circuit
Plumbing Supply	1/4" OD copper, braided stainless steel or PEX tubing
Plumbing Pressure	35–120 psi
Receptacle	3-prong grounding-type

ELECTRICAL

PLUMBING

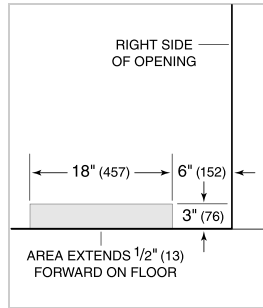
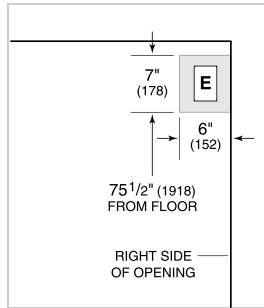

PANEL SPECIFICATIONS For complete panels specifications including width/height, weight requirements, thickness requirements and offset details visit subzero-wolf.com/builtinconfigurator.

NOTE: Dimensions in parenthesis are in millimeters unless otherwise specified

INTERIOR VIEW

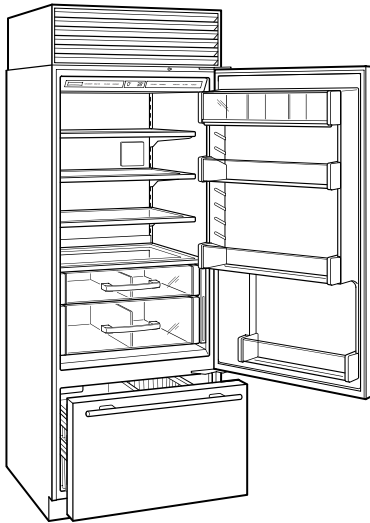

This illustration is intended for interior reference only and may not represent the exterior of the model being specified.

DIMENSIONS

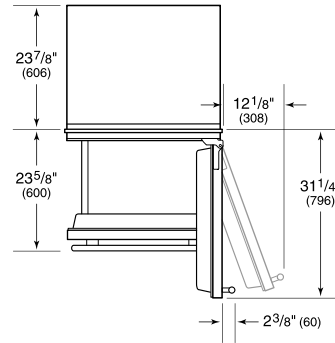
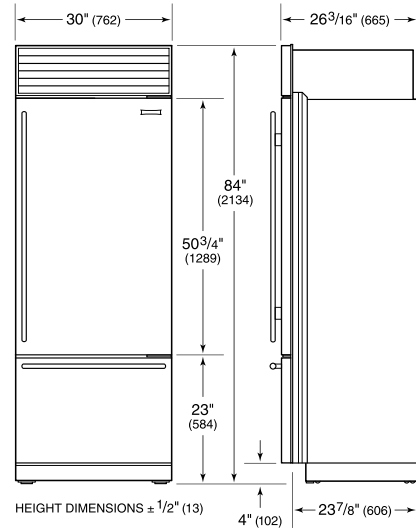

FLUSH INSET INSTALLATION

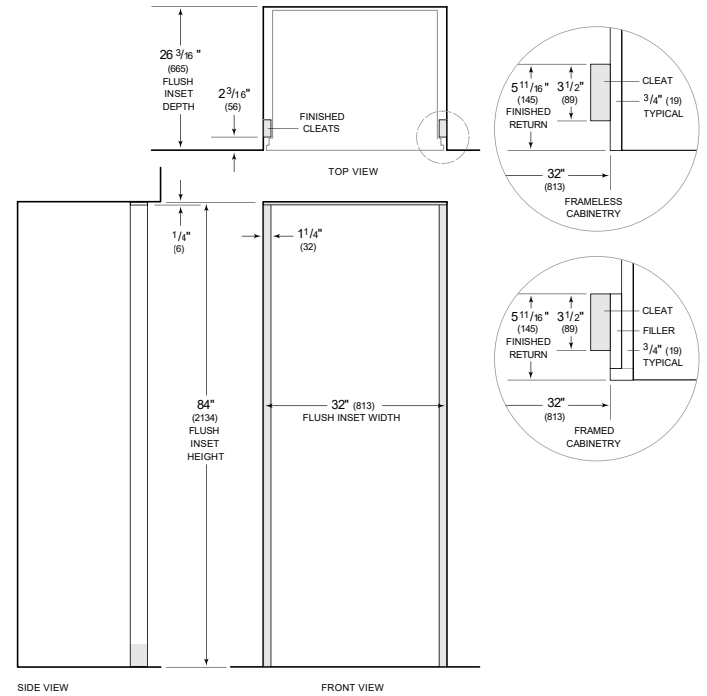

NOTE: 3/2" (89) finished returns and shaded areas will be visible and should be finished to match cabinetry. Shaded line represents profile of unit with 1/4" (19) panel.