

BI-30UG/O



## FEATURES

Monitor and control remotely with Wi-Fi connectivity

Accepts custom panels for an integrated look within cabinetry or stainless-steel accessory panels and handles to match other Sub-Zero, Wolf, and Cove products\*

Preserves refrigerated foods with cool, moist air and frozen foods with frigid, dry air

Fight spoilage and odors with a NASA-inspired air purification system

Locks in cold air to ensure freshness with magnetic door seals

Keeps produce fresher with high-humidity, sealed crisper and deli drawers

Controls temperature within one degree of setpoint

Filters ice, removing contaminants, chlorine taste, and odor

Yields ice automatically and "max ice" for additional production

Display food via a single, triple-pane and UV-resistant glass door

Ensures excellent visibility with bright lights

Refer to freshness cards for tips on food preservation, use, and care

## ACCESSORIES

90° Door Stop

Air Purification Cartridge

Custom Side Panel Mounting Kit

Egg Container

Legacy Dual Installation Kit

Legacy Dual Installation Kit with 60" Grille Frame

Legacy Dual Installation Kit with 66" Grille Frame

Legacy Grille Frame - 84"

Legacy Pro Louvered Flush Inset Grille - 84"

Legacy Stainless Steel Flush Inset Door Panel with Pro Handle

Legacy Stainless Steel Flush Inset Door Panel with Tubular Handle

Legacy Stainless Steel Flush Inset Drawer Panel with Pro Handle

Legacy Stainless Steel Flush Inset Drawer Panel with Tubular Handle

Legacy Stainless Steel Flush Inset Grille Panel

Legacy Stainless Steel Kickplate

Legacy Stainless Steel Pro Louvered Grille - 84"

Legacy Stainless Steel Side Panel

Water Filter

Water Filter

Water Filter By-Pass Plug

White Side Panel

Dual Installation Kit with Dual Wide Grille



## HANDLE ACCESSORIES

PRO



TUBULAR



## PRODUCT DETAILS

### REFRIGERATOR

- 4 glass refrigerator shelves (3 adjustable; 1 stationary)
- 1 high-humidity crisper drawer with adjustable dividers
- 1 deli drawer with adjustable dividers
- 1 adjustable dairy compartment
- LED refrigerator and freezer lights

### FREEZER

- 1 full-extension roll-out freezer drawer
- Automatic ice maker with removable ice container

---

Dual Flush Inset Installation Accessories

---

Flush Inset Installation Accessories

---

Framed Installation Accessories

---

Classic Overlay or Flush Inset Grille Frames

---

Classic Louvered Grilles

Accessories are available through an authorized dealer.  
For local dealer information, visit [subzero-wolf.com/locator](https://www.subzero-wolf.com/locator).

---

Specifications are subject to change without notice. This information was generated on February 27, 2024. Verify specifications prior to finalizing your cabinetry/enclosures.

**PRODUCT SPECIFICATIONS**

Model	BI-30UG/O
Dimensions	30"W x 84"H x 24"D
Refrigerator Capacity	13.1 cu. ft.
Freezer Capacity	4.2 cu. ft.
Electrical Supply	115 VAC, 60 Hz
Electrical Service	15 amp dedicated circuit
Plumbing Supply	1/4" OD copper, braided stainless steel or PEX tubing
Plumbing Pressure	35–120 psi
Receptacle	3-prong grounding-type

**ELECTRICAL**

**PLUMBING**

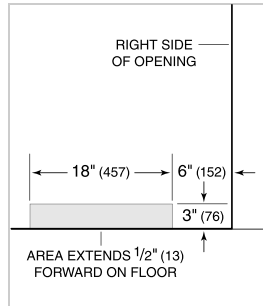
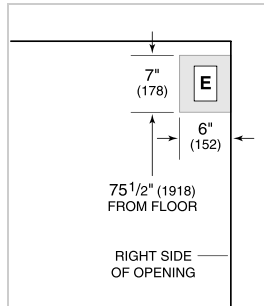

**PANEL SPECIFICATIONS** For complete panels specifications including width/height, weight requirements, thickness requirements and offset details visit [subzero-wolf.com/builtinconfigurator](http://subzero-wolf.com/builtinconfigurator).

**NOTE:** Dimensions in parenthesis are in millimeters unless otherwise specified

**INTERIOR VIEW**

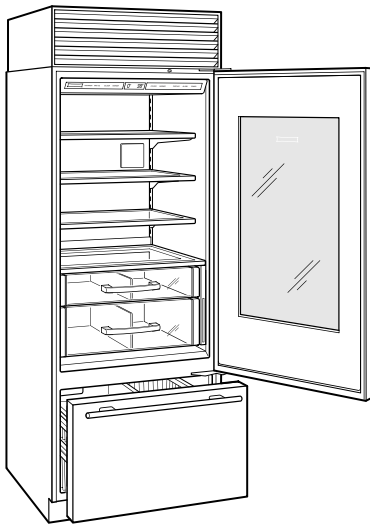

This illustration is intended for interior reference only and may not represent the exterior of the model being specified.

**DIMENSIONS**

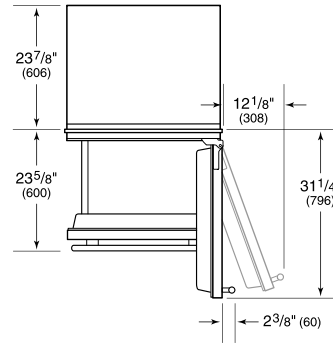
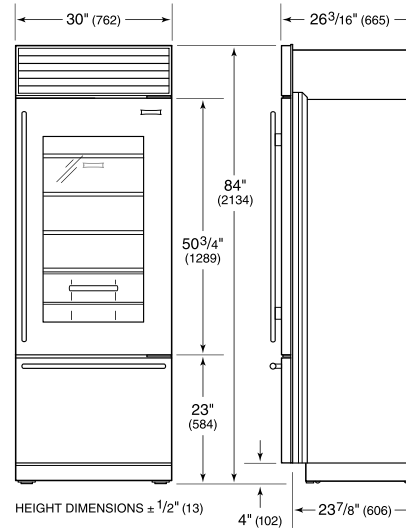

**FLUSH INSET INSTALLATION**

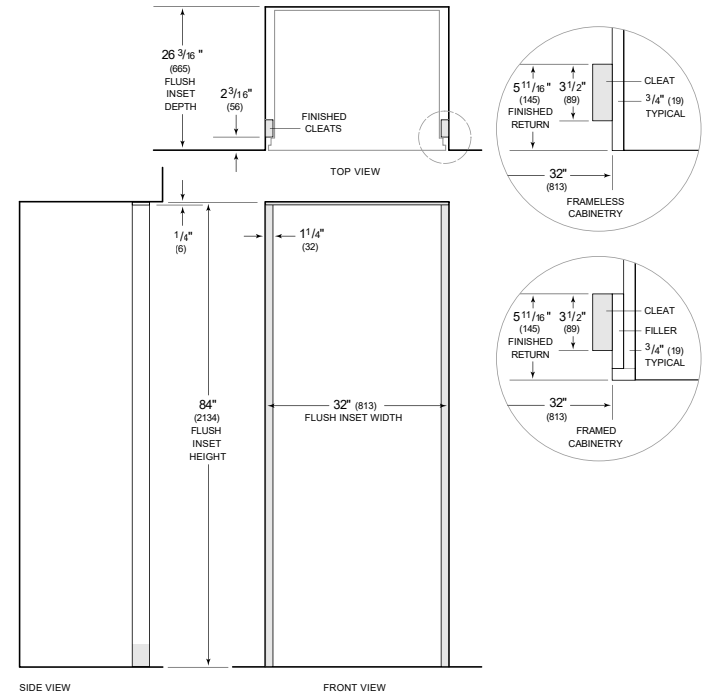

**NOTE:** 3/2" (89) finished returns and shaded areas will be visible and should be finished to match cabinetry. Shaded line represents profile of unit with 1/4" (19) panel.