

**DEU1550IP****FEATURES**

For extra peace of mind, if the unit senses a water leak, it will shut down to prevent further leakage and notify you through an alarm and the Owner's App.

MaxQuiet™ technology ensures near-silent operation

Intuitive cleaning system requires less user interaction

A subtle floor light shows the progress of the cleaning process

Produces up to 65 lbs. of clear cube-shaped ice (approximately 1 1/4" across) per day

Rounded ice scoop is specially designed to pick up as many cubes as possible

Panel-ready, with integrated hinges, to blend seamlessly into surrounding cabinetry

The intuitive controls match other Sub-Zero touchscreens and are located on top of the door for easy access and viewing

Use the Owner's App on your mobile device to start or stop ice making, remotely monitor the unit, adjust settings, and receive notifications on cleaning status

Sub-Zero's legendary quality means the ice maker will provide years of regular use even in harsh outdoor conditions

**ACCESSORIES**

Stainless Steel Solid Door Panels

Stainless Steel Dual Kickplates

Outdoor Stainless Steel Solid Door Panels

Accessories are available through an authorized dealer.  
For local dealer information, visit [subzero-wolf.com/locator](http://subzero-wolf.com/locator).

**HANDLE ACCESSORIES**

PRO



TUBULAR

**PRODUCT DETAILS****FREEZER**

- LED lighting
- Built-in ice scoop

**PRODUCT SPECIFICATIONS**

Model	DEU1550IP
Dimensions	15"W x 34 1/2"H x 23 1/8"D
Electrical Supply	115 VAC, 60 Hz
Electrical Service	15 amp dedicated circuit
Plumbing Supply	1/4" OD copper, braided stainless steel or PEX tubing
Plumbing Pressure	20–80 psi
Receptacle	3-prong grounding-type

**ELECTRICAL**

**PLUMBING**

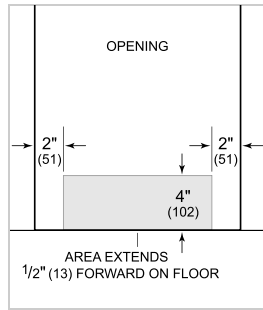
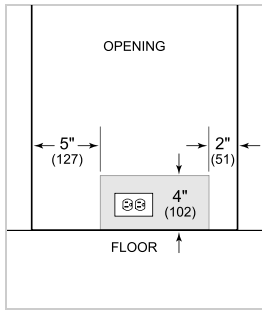

**NOTE:** The electrical outlet must be positioned with the grounding prong to the right of the thinner blades.

**PANEL SPECIFICATIONS** For complete panels specifications including width/height, weight requirements and thickness requirements visit [subzero-wolf.com/reveal](http://subzero-wolf.com/reveal).

**NOTE:** Dimensions in parenthesis are in millimeters unless otherwise specified

**ICE MAKER DRAIN** Ice maker models can be ordered with or without a drain pump. Models without a pump will drain water by gravity. A drain must be provided for all models.

**INTERIOR VIEW**

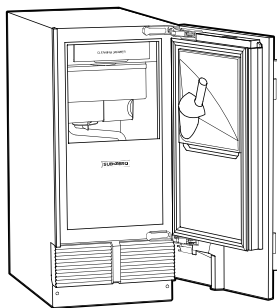

This illustration is intended for interior reference only and may not represent the exterior of the model being specified.

**DIMENSIONS**

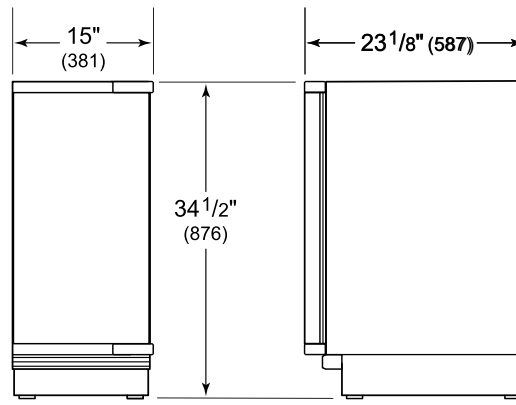

HEIGHT DIMENSIONS ± 1/2" (13)

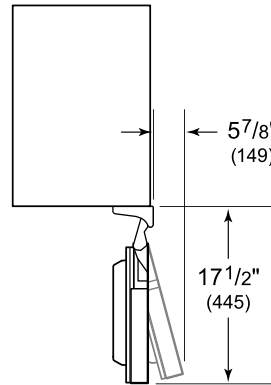

**STANDARD INSTALLATION**

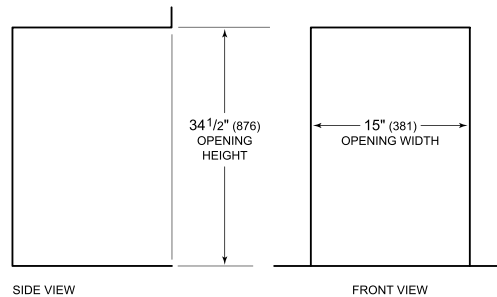
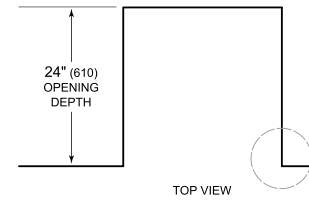

**NOTE:** 3 1/2" (89) finished returns will be visible and should be finished to match cabinetry.

