



Design Guide

REVISED 4/2026





Features and specifications are subject to change at any time without notice. Visit coveappliance.com/specs for the most up-to-date information.

Throughout this guide, dimensions may vary by $\pm \frac{1}{8}$ " (3). Dimensions in parentheses are millimeters unless otherwise specified.

Contents

- 4 Cove Dishwashers
- 5 Overall Dimensions
- 6 Opening Dimensions
- 7 Electrical / Plumbing Requirements
- 8 Door Panel
- 11 Cove Warranty

Cove Dishwashers

Cove dishwashers clean to a higher standard. They are built to ensure that every dish and utensil—including plastic containers, heavy saucepans, wire whisks, and even delicate china plates—emerge from the dishwasher spotlessly clean and dry. With a vast array of custom wash and dry options and interiors that adjust to accommodate any size or combination of dishes, Cove offers a clean you will never have to second-guess. All models can be fully integrated with custom cabinetry or stainless steel panels to complement any kitchen design.

DISHWASHER MODELS

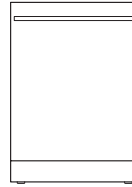

DW2451
DW2451/ADA

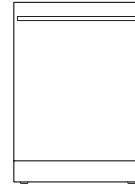

DW2451WS
DW2451WS/ADA
Water Softener



Overall Dimensions

DISHWASHER (STANDARD)

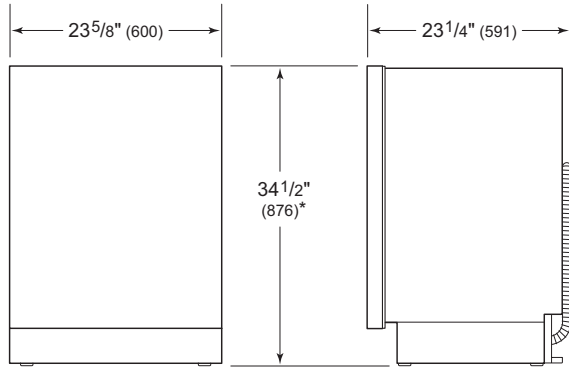

* $33\frac{3}{4}$ " (857) MIN TO $34\frac{3}{4}$ " (883) MAX

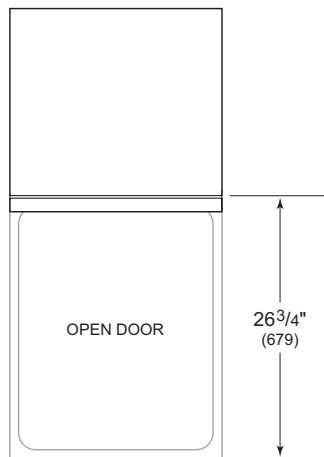

DISHWASHER (ADA HEIGHT)

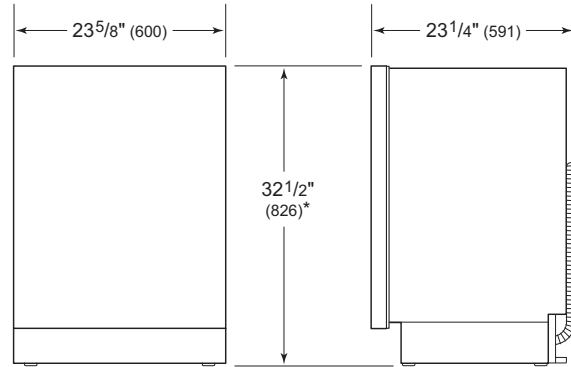

* $31\frac{7}{8}$ " (810) MIN TO $32\frac{7}{8}$ " (835) MAX

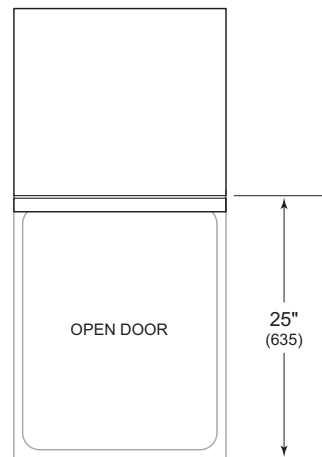

IMPORTANT NOTE: Overall dimensions do not include the door panel or handle. Dimensions will vary with panel thickness.

Opening Dimensions

DISHWASHER

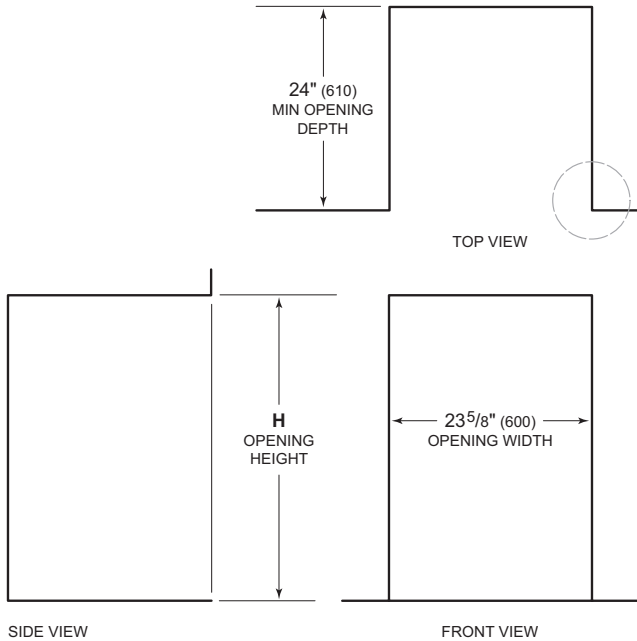

NOTE: 3 1/2" (89) finished returns will be visible and should be finished to match cabinetry.

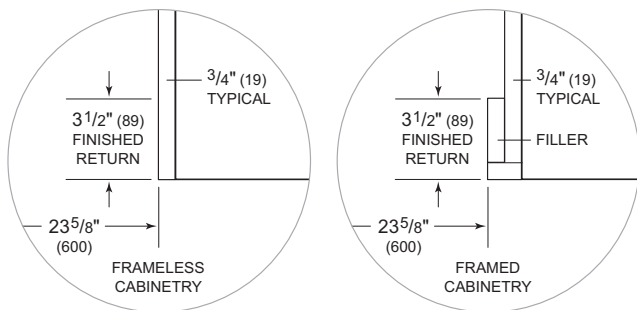

OPENING HEIGHT

H

Standard Models	34 1/2" (876)
ADA Height Models	32 1/2" (826)

OPENING WIDTH

Cove dishwashers accommodate varying opening widths. A 23 5/8" (60 cm) width provides minimum reveals and is ideal for new construction. A 24" (610) width is also common; however, reveals for a 24" (610) opening will be larger than the reveals for a 23 5/8" (60 cm) opening unless the panel width is adjusted accordingly. Refer to page 9 for more information.

OPENING DEPTH

Allow for panel thickness when planning the finished opening depth. Panels thicker than 3/4" (19) require additional depth if the unit is being installed flush. A minimum 3 1/2" (89) finished return is required on all sides of the opening. Framed cabinets require additional finished filler material behind the face frame for a proper installation. Refer to the illustration.

OPENING HEIGHT

Cove dishwashers accommodate varying opening heights. A 34 1/2" (876) height is typical, however, ADA height models accommodate height restricted openings and ADA height installations. Refer to the illustration and chart. The unit allows for 1" (25) of total height adjustment. Refer to page 5 for more information.

For openings exceeding the maximum product height, the door panel can extend above the top of the door, however, the door panel could affect control panel interaction. A filler above the unit is also required. Refer to the illustration below.

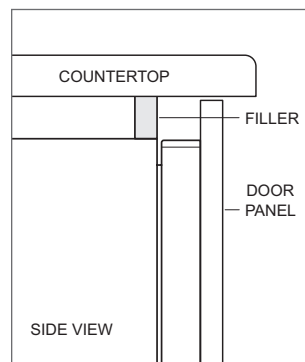

Panel height filler

Electrical Requirements

Installation must comply with all applicable electrical codes.

Locate the electrical supply within reach of the power cord, likely in an adjacent cabinet. Refer to the illustrations below. A separate circuit servicing only this appliance is required. A ground fault circuit interrupter (GFCI) outlet or breaker may be required, whichever complies with local codes.

ELECTRICAL REQUIREMENTS

Electrical Supply	115 VAC, 60 Hz
Service	15 amp dedicated circuit
Receptacle	3-prong grounding-type
Power Cord	6' (1.8 m)

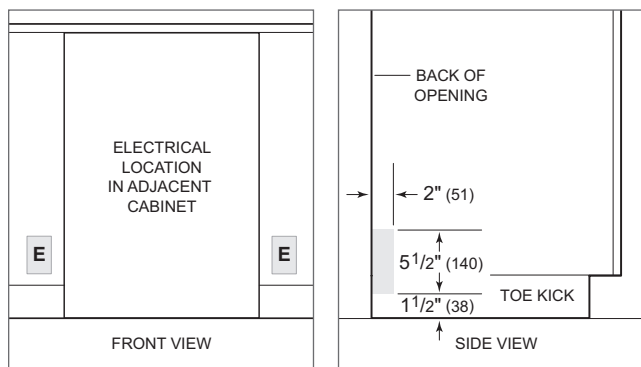

Electrical location

Electrical routing

Plumbing Requirements

Installation must comply with all applicable plumbing codes.

Locate the water supply and drain within reach of the water and drain connections, likely in an adjacent cabinet. If necessary, the drain tubing can be extended by a maximum of 5' (1.5 m). Route the water supply through the shaded area shown in the illustration below. Connect the water supply line to a hot water house supply with an easily accessible shut-off valve between the supply and the unit.

The drain tube connection must be 20" (508) to 43" (1092) above the bottom of the dishwasher leveling legs. Refer to the illustration below.

PLUMBING REQUIREMENTS

Water Connection	5' (1.5 m) braided tubing with 3/8" female compression fitting
Drain Connection	5' (1.5 m) corrugated tubing
Pressure	30–140 psi (2–9.7 bar)

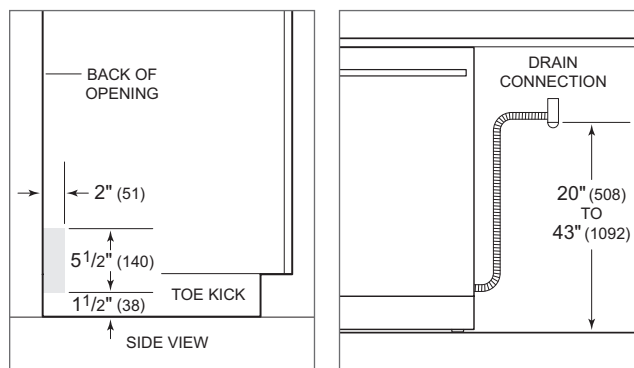

Water supply routing

Drain connection

Door Panel

CUSTOM PANEL

IMPORTANT NOTE: The dishwasher opening width determines the custom panel width. The panel width should be $\frac{1}{4}$ " (6) less than the opening width to achieve minimum reveals.

The panel dimensions in the chart below are based on a $34\frac{1}{2}$ " (876) opening for a standard height model and $32\frac{1}{2}$ " (826) for an ADA height model, with a 4" (102) toe kick and $\frac{1}{8}$ " (3) top reveal. For all other opening and toe kick heights, adjust the panel accordingly. The minimum panel height for a standard model is 28" (711) and 26" (660) for an ADA height model. The minimum toe kick height is 4" (102).

Finish all sides of the custom panel. They may be visible when the door is open.

Locate the handle near the top of the door. Refer to page 10 for standard handle lengths. Handle mounting hardware must be flush with the back of the door panel.

PANEL DIMENSIONS (STANDARD)	W	H
$23\frac{5}{8}$ " (60 cm) Opening	$23\frac{3}{8}$ " (594)	$30\frac{3}{8}$ " (772)
24" (610) Opening	$23\frac{3}{4}$ " (603)	$30\frac{3}{8}$ " (772)

PANEL DIMENSIONS (ADA HEIGHT)	W	H
$23\frac{5}{8}$ " (60 cm) Opening	$23\frac{3}{8}$ " (594)	$28\frac{3}{8}$ " (721)
24" (610) Opening	$23\frac{3}{4}$ " (603)	$28\frac{3}{8}$ " (721)

PANEL REQUIREMENTS

Max Weight (including handle)	20 lb (9 kg)*
Min Thickness	$\frac{1}{2}$ " (13)

*Less than 18 lb (9 kg) is optimal.

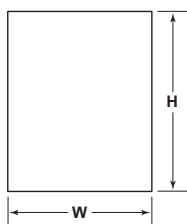

Panel dimensions

STAINLESS STEEL PANEL

Stainless steel accessory door panels are available in two widths to accommodate a $23\frac{5}{8}$ " (60 cm) or a 24" (610) opening. The panel dimensions in the chart below are based on a 4" (102) toe kick. The panels are available through an authorized Cove dealer. For local dealer information, use the showroom, sales, and service search tool on coveappliance.com.

PANEL DIMENSIONS (STANDARD)	W	H	D
$23\frac{5}{8}$ " (60 cm) Opening	$23\frac{3}{8}$ " (594)	$30\frac{3}{8}$ " (772)	$\frac{3}{4}$ " (19)
24" (610) Opening	$23\frac{3}{4}$ " (603)	$30\frac{3}{8}$ " (772)	$\frac{3}{4}$ " (19)

PANEL DIMENSIONS (ADA HEIGHT)	W	H	D
$23\frac{5}{8}$ " (60 cm) Opening	$23\frac{3}{8}$ " (594)	$28\frac{3}{8}$ " (721)	$\frac{3}{4}$ " (19)
24" (610) Opening	$23\frac{3}{4}$ " (603)	$28\frac{3}{8}$ " (721)	$\frac{3}{4}$ " (19)

Door Panel

KICKPLATE CLEARANCE

It is possible to adhere a custom kickplate to the factory kickplate. The height and thickness can vary, provided it does not impede the door panel rotation. Refer to the illustration below.

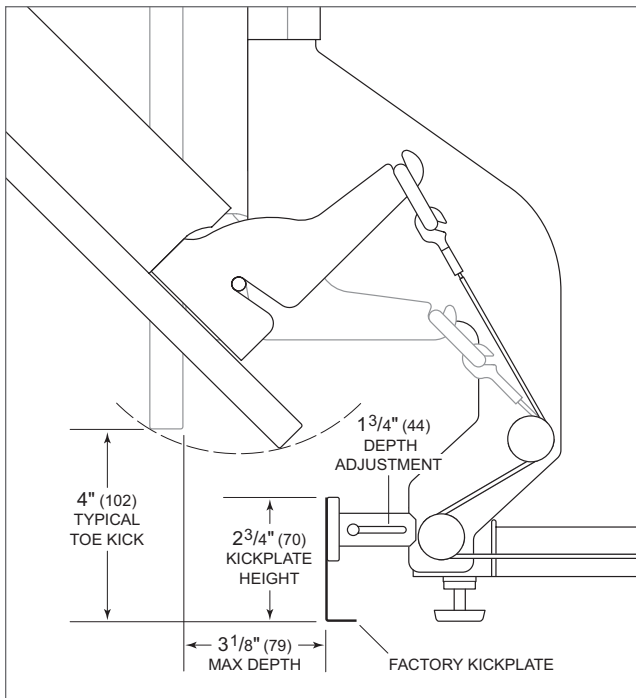

Toe kick area (side view)

KICKPLATE

IMPORTANT NOTE: The upper right corner of any kickplate exceeding 3 3/8" (86) in height must be notched to allow for airflow. Refer to the illustration below.

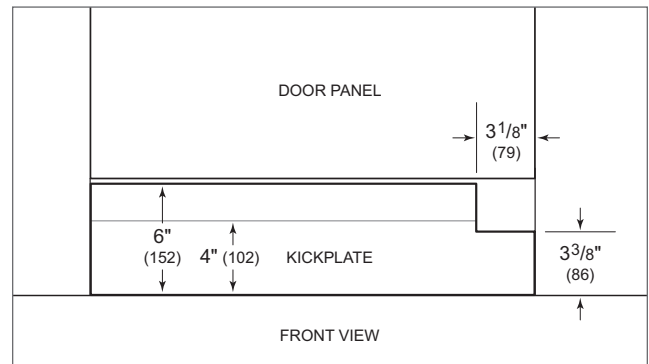

Kickplate notch

Door Panel

STANDARD HANDLES

Optional stainless steel tubular and pro handles are available through an authorized Cove dealer. For local dealer information, use the showroom, sales, and service search tool on coveappliance.com. Refer to the chart below for standard handle lengths for the dishwasher.

HANDLE LENGTH

Tubular	21¼" (540)
Pro	19½" (495)

Sub-Zero, Sub-Zero & Design, Sub-Zero & Snowflake Design, Dual Refrigeration, The Living Kitchen, Great American Kitchens The Fine Art of Kitchen Design, Wolf, Wolf & Design, Wolf Gourmet, W & Design, red colored knobs, Cove, and Cove & Design are registered trademarks and service marks of Sub-Zero Group, Inc. and its subsidiaries. All other trademarks are property of their respective owners in the United States and other countries.

Cove Appliance Residential Limited Warranty

FOR RESIDENTIAL USE

FULL TWO YEAR WARRANTY*

For two years from the date of original installation, this Cove Appliance product warranty covers all parts and labor to repair or replace, under normal residential use, any part of the product that proves to be defective in materials or workmanship. All service provided by Cove Appliance under the above warranty must be performed by Cove Factory Certified Service, unless otherwise specified by Cove Appliance, Inc. Service will be provided during normal business hours.

LIMITED FIVE YEAR PARTS WARRANTY

For five years from the date of original installation, Cove Appliance will repair or replace the following parts that prove to be defective in materials or workmanship: electronic control board, diverter valve, pump, and racks. If the owner uses Cove Factory Certified Service, the service provider will repair or replace these parts with the owner paying for all other costs, including labor. If the owner uses non-certified service, the owner must contact Cove Appliance, Inc. (using the information below) to receive repaired or replacement parts. Cove Appliance will not reimburse the owner for parts purchased from non-certified service or other sources.

LIMITED LIFETIME WARRANTY

For the life of the product, Cove Appliance will repair or replace the following parts that prove to be defective in materials or workmanship: stainless steel tub and door liner (excludes surface corrosion, scratches, discoloration, weather and atmospheric related staining, and minor surface rust and oxidation). If the owner uses Cove Factory Certified Service, the service provider will repair or replace these parts with the owner paying for all other costs, including labor. If the owner uses non-certified service, the owner must contact Cove Appliance, Inc. (using the information below) to receive repaired or replacement parts. Cove Appliance will not reimburse the owner for parts purchased from non-certified service or other sources.

TERMS APPLICABLE TO EACH WARRANTY

The warranty applies only to products installed for normal residential use. The warranty applies only to products installed in any one of the fifty states of the United States, the District of Columbia, or the ten provinces of Canada. This warranty does not cover any parts or labor to correct any defect caused by negligence, accident or improper use, maintenance, installation, service, or repair.

THE REMEDIES DESCRIBED ABOVE FOR EACH WARRANTY ARE THE ONLY ONES THAT COVE APPLIANCE, INC. WILL PROVIDE, EITHER UNDER THIS WARRANTY OR UNDER ANY WARRANTY ARISING BY OPERATION OF LAW. COVE APPLIANCE, INC. WILL NOT BE RESPONSIBLE FOR ANY CONSEQUENTIAL OR INCIDENTAL DAMAGES ARISING FROM THE BREACH OF THIS WARRANTY OR ANY OTHER WARRANTY, WHETHER EXPRESS, IMPLIED, OR STATUTORY.

Some states do not allow the exclusion or limitation of incidental or consequential damages, so the above limitation or exclusion may not apply to you. This warranty gives you specific legal rights, and you may also have other legal rights that vary from state to state.

To receive parts and/or service and the name of Cove Factory Certified Service nearest you, contact Cove Appliance, Inc., P.O. Box 44848, Madison, WI 53744; check the Product Support section of our website, coveappliance.com, email us at customerservice@subzero.com, or call 800-222-7820.

*Stainless steel (doors, panels, handles, product frames, and interior surfaces) are covered by a limited 60-day parts and labor warranty for cosmetic defects.





COVEAPPLIANCE.COM